

Datasheet - ZR 256-11z



Position switch / Thermoplastic enclosure 256 - DIN EN 50047 with Actuator / 256 Roller plunger R



- 2 cable entries M 20 x 1.5
- Snap action with constant contact pressure up to switching point
- Mounting details to EN 50047
- thermoplastic enclosure
- Double-insulated
- 58 mm x 50,5 mm x 31 mm
- Good resistance to oil and petroleum spirit
- Wide range of alternative actuators
- Actuator heads can be repositioned by 4 x 90°

(Minor differences between the printed image and the original product may exist!)

Ordering details

Product type description	ZR 256-11Z
Article number	1160535
EAN code	4030661190440

Approval

Approval	 USA/CAN  CCC
----------	--

Classification

Standards	EN ISO 13849-1
B _{10d} Normally-closed contact (NC)	20.000.000
Mission time notice	20 Years
	$MTTF_d = \frac{B_{10d}}{0,1 \times n_{op}}$ $n_{op} = \frac{d_{op} \times h_{op} \times 3600 \text{ s/h}}{t_{zyklus}}$

Global Properties

Product name	Z 256 Rollendruckbolzen R
Standards	EN 60947-5-1 BG-GS-ET-15

Compliance with the Directives (Y/N) 	Yes
Suitable for safety functions (Y/N)	Yes
Actuator type	C to EN 50047
Materials	
- Material of the housings	glass-fibre reinforced thermoplastic, self-extinguishing
- Material of the contacts	Silver
Housing coating	Other
Housing construction form	Norm construction design
Weight	85 g

Mechanical data

Design of actuating element	Roller plunger
Design of electrical connection	Screw connection
Cable section	
- Min. Cable section	1.5 mm ²
- Max. Cable section	2.5 mm ²
Mechanical life	20.000.000 operations
Switching frequency	max. 5000 /h
Actuating force	min. 9 N
Bounce duration	< 3 ms
Switchover time	< 5.5 ms
Positive break force	19 N
Actuating speed with actuating angle 30° to switch axis	
- Min. Actuating speed	20 mm/min
- Max. Actuating speed	1 m/s
notice	All indications about the cable section are including the conductor ferrules.

Ambient conditions

Ambient temperature	
- Min. environmental temperature	- 30°C
- Max. environmental temperature	+ 80°C
Protection class	IP67

Electrical data

Design of control element	Normally open contact (NO), Opener (NC)
Switching principle	Snap switch element
- positive break NC contact 	
Number of auxiliary contacts	1 piece
Number of safety contacts	1 piece
Rated impulse withstand voltage U _{imp}	6 kV
Rated insulation voltage U _i	500 V
Thermal test current I _{the}	10 A
Utilisation category	AC-15: 230 V / 4 A, DC-13: 24 V / 1 A
Max. fuse rating	6 A gG D-fuse

Dimensions

Dimensions of the sensor	
- Width of sensor	58 mm
- Height of sensor	67 mm

- Length of sensor

31 mm

Diagram

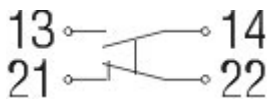

Note Diagram

- positive break NC contact
- active
- no active
- Normally-open contact
- Normally-closed contact

Switch travel diagram

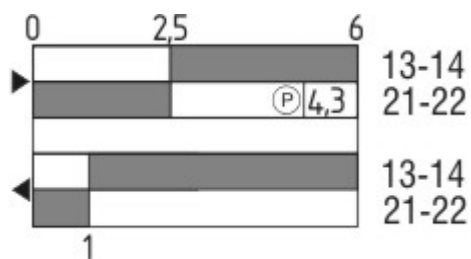

Notes Switch travel diagram

- Contact closed
- Contact open
- Setting range
- Break point
- Positive opening sequence/- angle
- VS** adjustable range of NO contact
- VÖ** adjustable range of NC contact
- N** after travel

Ordering suffix

The applicable ordering suffix is added at the end of the part number of the safety switch.

Order example: ZR 256-11z-1637

...-1637 0,3 µm gold-plated contacts

...-NPT Cable entry NPT 1/2"

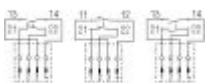

...-ST M12 connector with A-coding

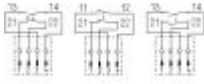

...- 2310

M12 connector with B-coding

...-1297

Enclosure with transverse slotted holes

Ordering code

(1)(2) 2(3)6-(4)Z(5)-(6)-(7)-(8)-(9)

(1)

Z Snap action

T Slow action

(2)

S Plunger S

R Roller plunger R

4S Plunger 4S

4R Roller plunger 4R

1R Offset roller lever 1R

K Offset roller lever K

3K Angle roller lever 3K

4K Angle roller lever 4K

K4 Angle roller lever K4

1H Roller lever 1H

7H Roller lever 7H

10H Rod lever 10H

12H Roller lever 12H

14H Roller lever 14H

(3)

3 slim design

5 large design

(4)

02 2 Opener (NC)

11 1 Normally open contact (NO) / 1 Opener (NC)

20 2 Normally open contact (NO), (*Switch with 2 NO contacts are not for security tasks*)

(5)

H Slow action with staggered contacts

UE Slow action with overlapping contacts

(6)

without Cable entry M20

ID IDC method of termination

NPT cable entry NPT 1/2"

ST M12 connector with A-coding

2310 M12 connector with B-coding

(7)

1297 Enclosure with transverse slotted holes

(8)

2138 Roller lever 7H for Position switches with safety function

(9)

Documents

Operating instructions and Declaration of conformity (de) 644 kB, 06.04.2010

http://www.schmersal.net/Bilddata/Si_f1/Pdf/Zt235/bedien/DE/mrl_ZT235_236_de.pdf

Operating instructions and Declaration of conformity (pt) 451 kB, 01.03.2010

http://www.schmersal.net/Bilddata/Si_f1/Pdf/Zt235/bedien/PT/mrl_ZT235_236_pt.pdf

Operating instructions and Declaration of conformity (nl) 383 kB, 27.11.2009

http://www.schmersal.net/Bilddata/Si_f1/Pdf/Zt235/bedien/NL/mrl_ZT235_236_nl.pdf

Operating instructions and Declaration of conformity (en) 535 kB, 01.03.2010

http://www.schmersal.net/Bilddata/Si_f1/Pdf/Zt235/bedien/EN/mrl_ZT235_236_en.pdf

Operating instructions and Declaration of conformity (es) 391 kB, 27.11.2009

http://www.schmersal.net/Bilddata/Si_f1/Pdf/Zt235/bedien/ES/mrl_ZT235_236_es.pdf

Operating instructions and Declaration of conformity (fr) 399 kB, 27.11.2009

http://www.schmersal.net/Bilddata/Si_f1/Pdf/Zt235/bedien/FR/mrl_ZT235_236_fr.pdf

Operating instructions and Declaration of conformity (it) 375 kB, 27.11.2009

http://www.schmersal.net/Bilddata/Si_f1/Pdf/Zt235/bedien/IT/mrl_ZT235_236_it.pdf

Operating instructions and Declaration of conformity (jp) 562 kB, 27.11.2009

http://www.schmersal.net/Bilddata/Si_f1/Pdf/Zt235/bedien/JP/mrl_ZT235_236_jp.pdf

CCC certification (en) 584 kB, 12.12.2006

http://www.schmersal.net/Bilddata/Si_f1/Pdf/Zt235/zertifikat/q_347p02.pdf

CCC certification (cn) 605 kB, 12.12.2006

http://www.schmersal.net/Bilddata/Si_f1/Pdf/Zt235/zertifikat/q_347p03.pdf

Images

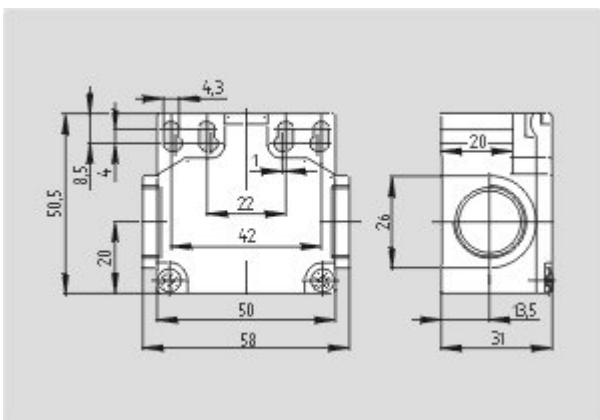

Dimensional drawing (basic component)

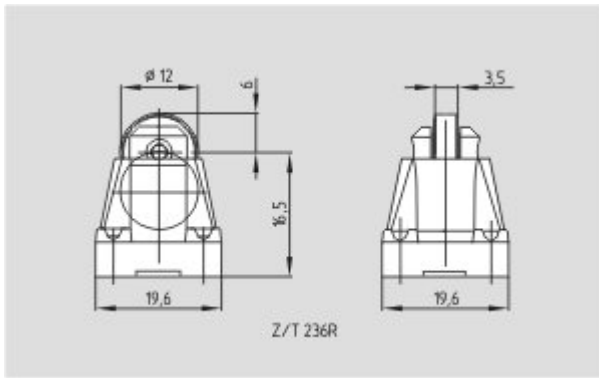

Dimensional drawing (actuator)

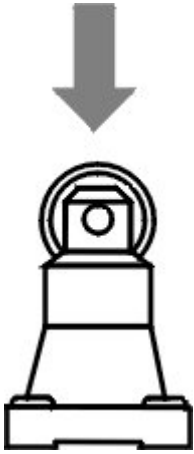

Operating principle
